

Varenummer: 2010502NM12ILASS
 Beskrivelse: E+G Hurtigkobling
 GN 1050-2N-M12-I-L-ASS

Mål

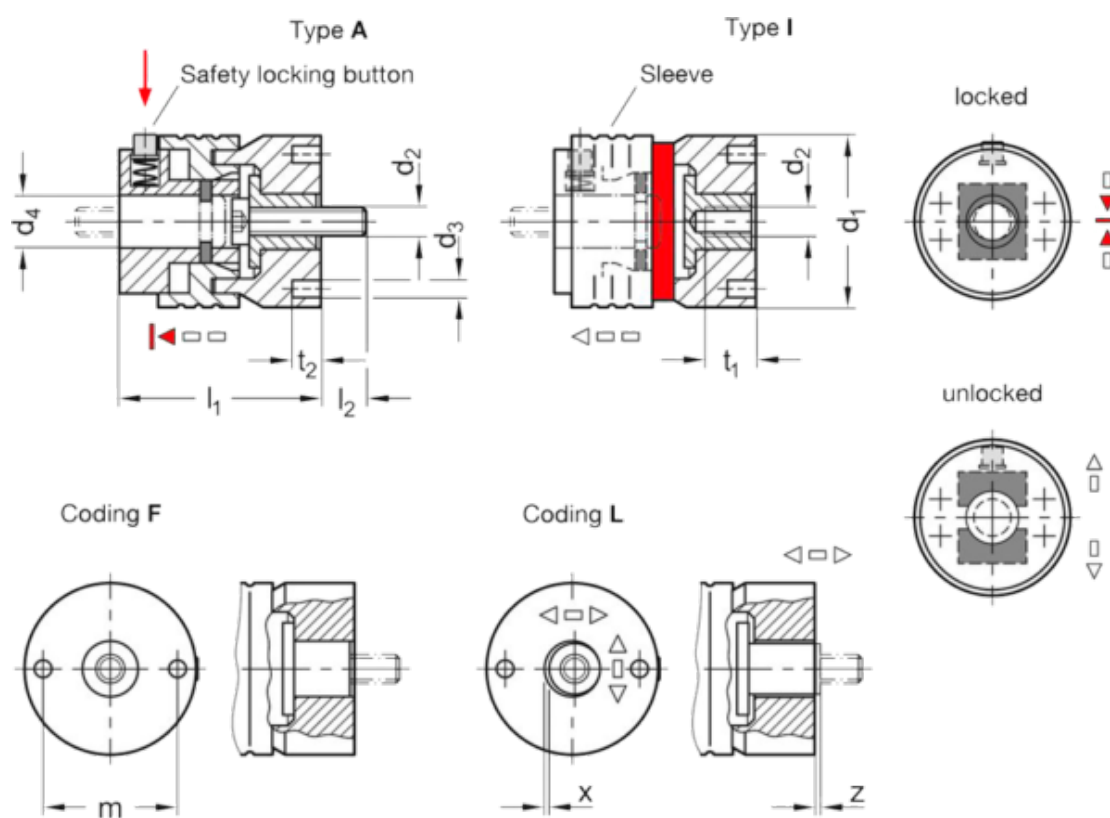

D1	= 53	T2	= 10
D2	= M 12	Vægt	= 397
D3	= 6	X	= 0.75
D4	= 18.5	Z	= 0.4
L1	= 70.1		
L2	= 40		
M	= 18		
Størrelse	= 2N		